

Product Category

G1NGPF-04

Product Line

G-Series® Needle Valve (G-N Series)

Part Description

Globe Needle Valve with Female Pipe Thread (NPT) Ends

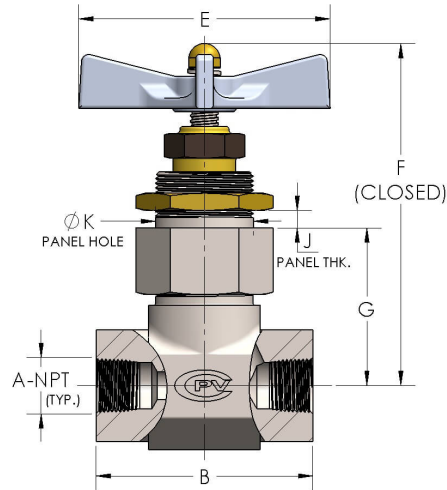

## DIMENSIONS

Orifice	0.313
A-NPT :	1/4"-18
B	2.75
E	3.50
F	4.56
G	1.81
J (max.)	0.44
K	1.2



## GENERAL

<b>Pressure Rating</b>	6000 PSI
<b>Temperature Range</b>	-15°F to 400°F (-26°C to 204°C)
<b>Standard Soft Goods</b>	[-G] Polyurethane® Packing and Viton® O-Rings
<b>Cartridge Type</b>	Needle
<b>Connection Type</b>	Female Pipe Thread (NPT)
<b>Connection Size</b>	1/4"
<b>Body Material</b>	316/L Stainless Steel, ASTM A182, UNS S31603
<b>Bonnet Material</b>	316/L Stainless Steel, ASTM A276, UNS S31603

## OPTIONS

<b>[-VC] Vacuum Service</b>	Option to add additional softgoods for internal vacuum service.
<b>Optional Soft Goods</b>	[-B] Polyurethane® Packing and Buna-N O-Rings, [-C] Viton® Packing & O-Rings, [-D] EPDM Packing & O-Rings