

Product Category

G1NGPS-06-NO

Product Line

FloMaster® Actuated G-Series® Needle Valves (G-N Series)

Part Description

Globe Needle Actuated Valve, Socketweld Pipe Ends, Normally Open

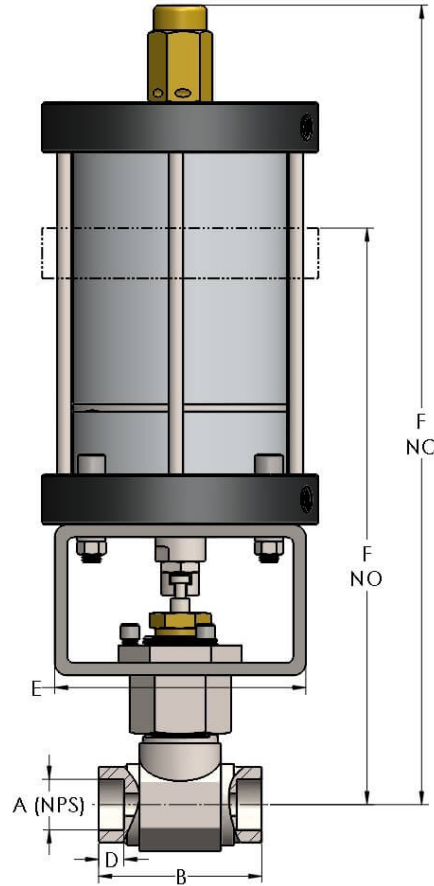

DIMENSIONS

Orifice	0.313
A (NPS)	0.675
B	2.50
D	0.380
E	4.00
F (Normally Open)	9.85
F (Normally Closed)	13.25



GENERAL

Pressure Rating	6000 PSI
Temperature Range	-15°F to 400°F (-26°C to 204°C)
Standard Soft Goods	[-G] Polyurethane® Packing and Viton® O-Rings
Cartridge Type	Needle
Connection Type	Socketweld Pipe
Connection Size	3/8"
Body Material	316/L Stainless Steel, ASTM A182, UNS S31603
Bonnet Material	316/L Stainless Steel, ASTM A276, UNS S31603

OPTIONS

[-VC] Vacuum Service	Option to add additional softgoods for internal vacuum service.
Optional Soft Goods	[-B] Polyurethane® Packing and Buna-N O-Rings, [-C] Viton® Packing & O-Rings, [-D] EPDM Packing & O-Rings