

Product Category

G1SGPF-08

Product Line

G-Series® Shutoff Valve (G-S Series)

Part Description

Globe Shutoff Valve with Female Pipe Thread (NPT) Ends

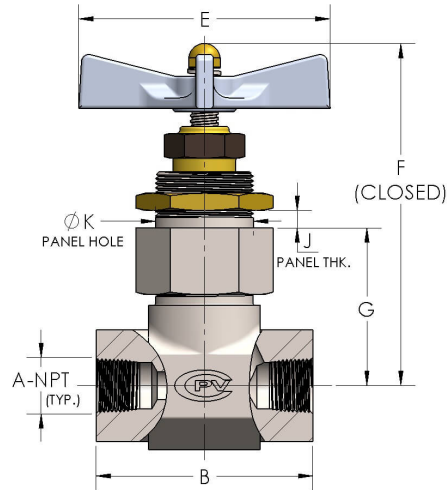

DIMENSIONS

Orifice	0.313
A-NPT :	1/2"-14
B	3.13
E	3.50
F	4.56
G	1.81
J (max.)	0.44
K	1.2



GENERAL

Pressure Rating	6000 PSI
Temperature Range	-15°F to 400°F (-26°C to 204°C)
Standard Soft Goods	[-G] Polyurethane® Packing and Viton® O-Rings
Cartridge Type	Shutoff
Connection Type	Female Pipe Thread (NPT)
Connection Size	1/2"
Body Material	316/L Stainless Steel, ASTM A182, UNS S31603
Bonnet Material	316/L Stainless Steel, ASTM A276, UNS S31603

OPTIONS

[-VC] Vacuum Service	Option to add additional softgoods for internal vacuum service.
Optional Soft Goods	[-B] Polyurethane® Packing and Buna-N O-Rings, [-C] Viton® Packing & O-Rings, [-D] EPDM Packing & O-Rings