

**Product Category**

G3NGPF-12-NC

**Product Line**

FloMaster® Actuated G-Series® Needle Valves (G-N Series)

**Part Description**

Globe Needle Actuated Valve, Female NPT Ends, Normally Closed

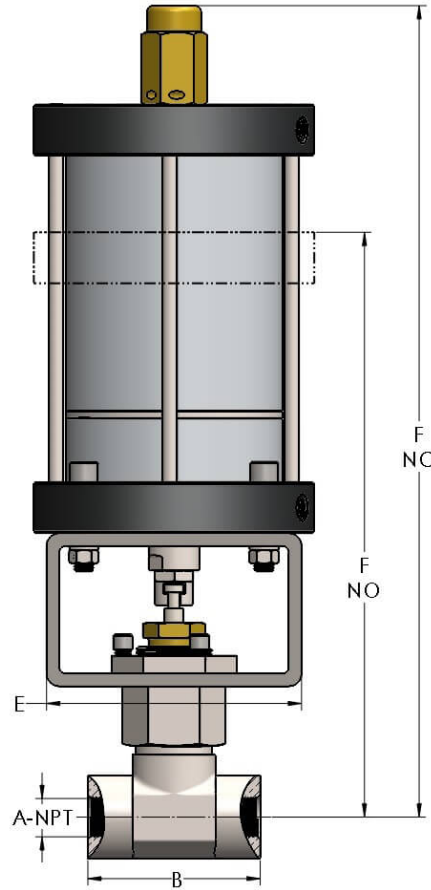

## DIMENSIONS

Orifice	0.500
A-NPT :	3/4"-14
B	4.00
E	6.00
F (Normally Open)	12.35
F (Normally Closed)	18.7



## GENERAL

<b>Pressure Rating</b>	6000 PSI
<b>Temperature Range</b>	-15°F to 400°F (-26°C to 204°C)
<b>Standard Soft Goods</b>	[-G] Polyurethane® Packing and Viton® O-Rings
<b>Cartridge Type</b>	Needle
<b>Connection Type</b>	Female Pipe Thread (NPT)
<b>Connection Size</b>	3/4"
<b>Body Material</b>	316/L Stainless Steel, ASTM A182, UNS S31603
<b>Bonnet Material</b>	316/L Stainless Steel, ASTM A276, UNS S31603

## OPTIONS

<b>[-VC] Vacuum Service</b>	Option to add additional softgoods for internal vacuum service.
<b>Optional Soft Goods</b>	[-B] Polyurethane® Packing and Buna-N O-Rings, [-C] Viton® Packing & O-Rings, [-D] EPDM Packing & O-Rings