

Product Category

G4SGPF-12-NC

Product Line

FloMaster® Actuated G-Series® Shutoff Valves (G-S Series)

Part Description

Globe Shutoff Actuated Valve, Female NPT Ends, Normally Closed

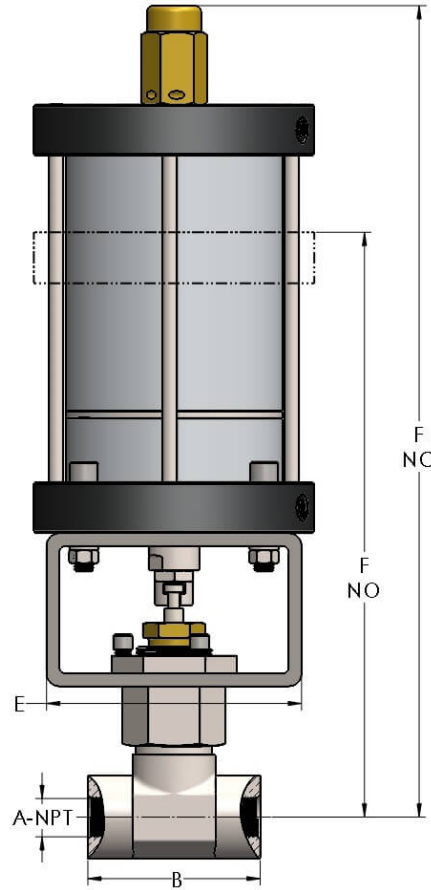

DIMENSIONS

| | |
|---------------------|---------|
| Orifice | 0.625 |
| A-NPT : | 3/4"-14 |
| B | 4.00 |
| E | 6.00 |
| F (Normally Open) | 12.5 |
| F (Normally Closed) | 18.88 |



GENERAL

| | |
|----------------------------|---|
| Pressure Rating | 4500 PSI |
| Temperature Range | -15°F to 400°F (-26°C to 204°C) |
| Standard Soft Goods | [-G] Polyurethane® Packing and Viton® O-Rings |
| Cartridge Type | Shutoff |
| Connection Type | Female Pipe Thread (NPT) |
| Connection Size | 3/4" |
| Body Material | 316/L Stainless Steel, ASTM A182, UNS S31603 |
| Bonnet Material | 316/L Stainless Steel, ASTM A276, UNS S31603 |

OPTIONS

| | |
|-----------------------------|---|
| [-VC] Vacuum Service | Option to add additional softgoods for internal vacuum service. |
| Optional Soft Goods | [-B] Polyurethane® Packing and Buna-N O-Rings, [-C] Viton® Packing & O-Rings, [-D] EPDM Packing & O-Rings |