

Product Category
Part Description

H804T-02-M
Blank Threadpiece

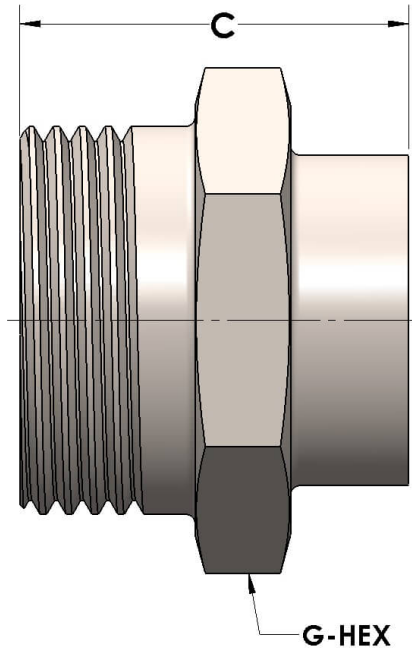

DIMENSIONS

C	0.63
G-HEX	0.5

GENERAL

Pressure Rating	6000 PSI
Threadpiece Material	Monel®, ASTM B164, UNS N04405
O-Ring Material	Viton® Fluorocarbon Type 1, Class 2 (90 durometer)