

Product Category

H804T-08-SS316L

Part Description

Blank Threadpiece

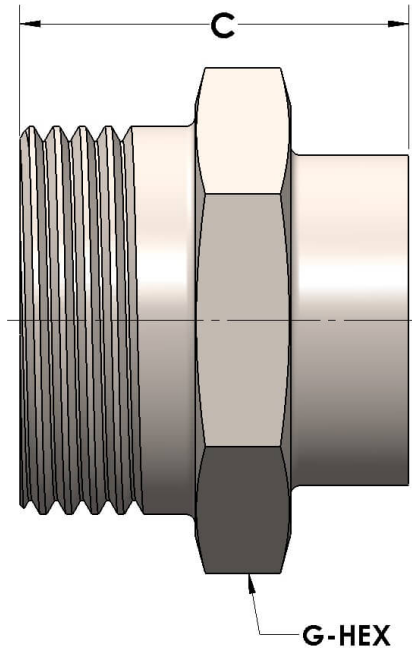

DIMENSIONS

C	0.94
G-HEX	0.88

GENERAL

Pressure Rating	6000 PSI
Threadpiece Material	316/L Stainless Steel, ASTM A276, UNS S31600/03
O-Ring Material	Viton® Fluorocarbon Type 1, Class 2 (90 durometer)