

Product Category
Part Description

H804T-12-M
Blank Threadpiece

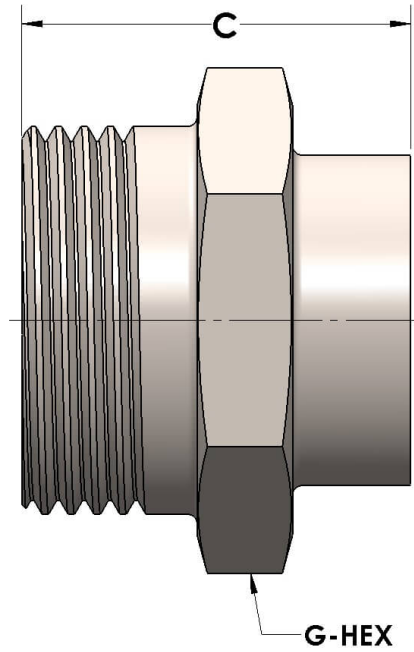

DIMENSIONS

C	1.25
G-HEX	1.38

GENERAL

Pressure Rating	6000 PSI
Threadpiece Material	Monel®, ASTM B164, UNS N04405
O-Ring Material	Viton® Fluorocarbon Type 1, Class 2 (90 durometer)