

Product Category

H804T-24-M

Part Description

Blank Threadpiece

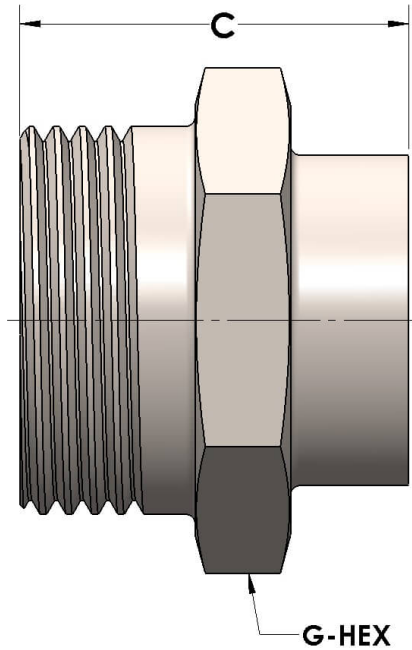

DIMENSIONS

C	1.56
G-HEX	2.25

GENERAL

Pressure Rating	6000 PSI
Threadpiece Material	Monel®, ASTM B164, UNS N04405
O-Ring Material	Viton® Fluorocarbon Type 1, Class 2 (90 durometer)