

Product Category

H805-02-SS316L

Part Description

Straight Thread Plug

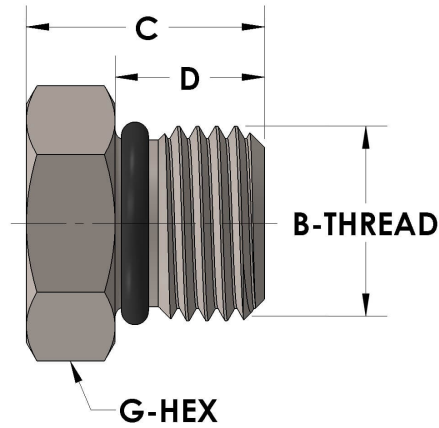

## DIMENSIONS

<b>B-THREAD</b>	.313" - 24UNF
<b>C</b>	0.60
<b>D</b>	0.360
<b>G-HEX</b>	0.44

## GENERAL

<b>Pressure Rating</b>	6000 PSI
<b>Threadpiece Material</b>	316/L Stainless Steel, ASTM A276, UNS S31600/03
<b>O-Ring Material</b>	Viton® Fluorocarbon Type 1, Class 2 (90 durometer)