

Product Category

H809-04-S

Part Description

Socketweld/braze Tube Cross Assembly

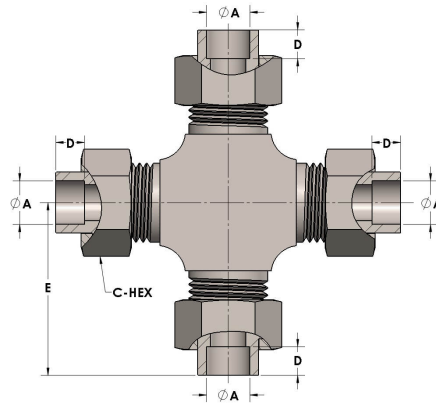

DIMENSIONS

A	0.250
C-HEX	0.63
D	0.190
E	1.19

GENERAL

Pressure Rating	6000 PSI
Assembly Material	Carbon Steel, ASTM A108
O-Ring Material	Viton® Fluorocarbon Type 1, Class 2 (90 durometer)
Connection 1 Type	Female Tube Socket
Connection 1 Size	1/4" Tube O.D. (-04)
Connection 2 Type	Female Tube Socket
Connection 2 Size	1/4" Tube O.D. (-04)
Connection 3 Type	Female Tube Socket
Connection 3 Size	1/4" Tube O.D. (-04)
Connection 4 Type	Female Tube Socket
Connection 4 Size	1/4" Tube O.D. (-04)