

Product Category

H809-12-SS316L

Part Description

Socketweld/braze Tube Cross Assembly

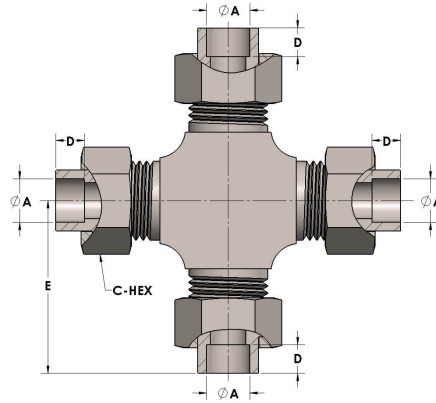

DIMENSIONS

A	0.750
C-HEX	1.38
D	0.440
E	2.25

GENERAL

Pressure Rating	6000 PSI
Assembly Material	316/L Stainless Steel, ASTM A276, UNS S31600/03
O-Ring Material	Viton® Fluorocarbon Type 1, Class 2 (90 durometer)
Connection 1 Type	Female Tube Socket
Connection 1 Size	3/4" Tube O.D. (-12)
Connection 2 Type	Female Tube Socket
Connection 2 Size	3/4" Tube O.D. (-12)
Connection 3 Type	Female Tube Socket
Connection 3 Size	3/4" Tube O.D. (-12)
Connection 4 Type	Female Tube Socket
Connection 4 Size	3/4" Tube O.D. (-12)