

Product Category

H814-04-02-04-SS316L

Part Description

Tube to Female Pipe Thread Run Tee Assembly

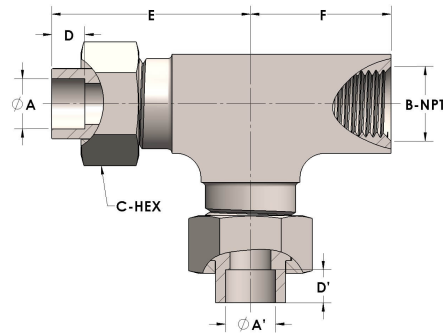

DIMENSIONS

A	0.250
A'	0.250
B-NPT	1/8" - 27
C-HEX	0.63
D	0.190
D'	0.190
E	1.19
F	0.81

GENERAL

Pressure Rating	6000 PSI
Assembly Material	316/L Stainless Steel, ASTM A276, UNS S31600/03
O-Ring Material	Viton® Fluorocarbon Type 1, Class 2 (90 durometer)
Connection 1 Type	Female Tube Socket
Connection 1 Size	1/4" Tube O.D. (-04)
Connection 3 Type	Female Tube Socket
Connection 3 Size	1/4" Tube O.D. (-04)