

Product Category

H814-08-06-08-SS316L

Part Description

Tube to Female Pipe Thread Run Tee Assembly

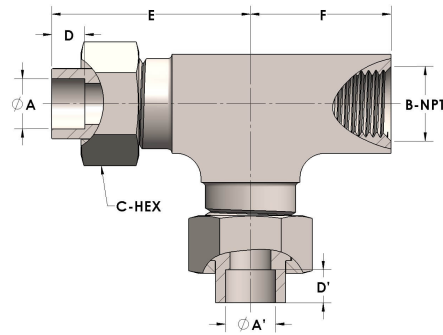

DIMENSIONS

A	0.500
A'	0.500
B-NPT	3/8" - 18
C-HEX	0.94
D	0.310
D'	0.310
E	1.69
F	1.19

GENERAL

Pressure Rating	4500 PSI
Assembly Material	316/L Stainless Steel, ASTM A276, UNS S31600/03
O-Ring Material	Viton® Fluorocarbon Type 1, Class 2 (90 durometer)
Connection 1 Type	Female Tube Socket
Connection 1 Size	1/2" Tube O.D. (-08)
Connection 3 Type	Female Tube Socket
Connection 3 Size	1/2" Tube O.D. (-08)