

Product Category

H814-10-08-10-S

Part Description

Tube to Female Pipe Thread Run Tee Assembly

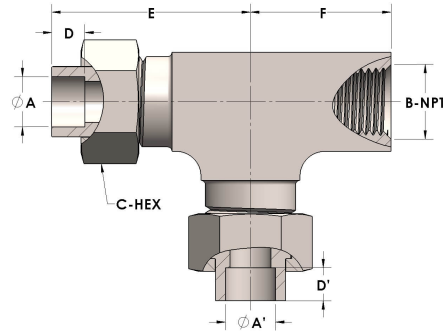

DIMENSIONS

A	0.630
A'	0.630
B-NPT	1/2" - 14
C-HEX	1.13
D	0.380
D'	0.380
E	2.06
F	1.44

GENERAL

Pressure Rating	4500 PSI
Assembly Material	Carbon Steel, ASTM A108
O-Ring Material	Viton® Fluorocarbon Type 1, Class 2 (90 durometer)
Connection 1 Type	Female Tube Socket
Connection 1 Size	5/8" Tube O.D. (-10)
Connection 3 Type	Female Tube Socket
Connection 3 Size	5/8" Tube O.D. (-10)