

Product Category

H814-12-12-12-M

Part Description

Tube to Female Pipe Thread Run Tee Assembly

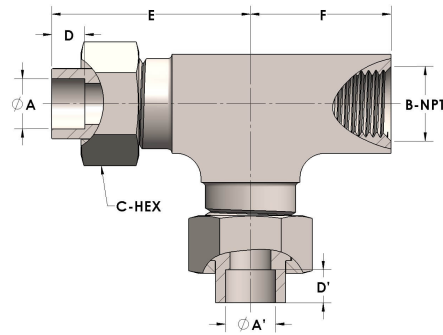

## DIMENSIONS

A	0.750
A'	0.750
B-NPT	3/4" - 14
C-HEX	1.38
D	0.440
D'	0.440
E	2.25
F	1.56

## GENERAL

Pressure Rating	3000 PSI
Tailpiece Material	Monel®, ASTM B164, UNS N04405
Threadpiece Material	Monel®, ASTM B564, UNS N04400
O-Ring Material	Viton® Fluorocarbon Type 1, Class 2 (90 durometer)
Connection 1 Type	Female Tube Socket
Connection 1 Size	3/4" Tube O.D. (-12)
Connection 3 Type	Female Tube Socket
Connection 3 Size	3/4" Tube O.D. (-12)