

Product Category

H819-08-M

Part Description

Direct Socketweld/Braze Cross (Tube)

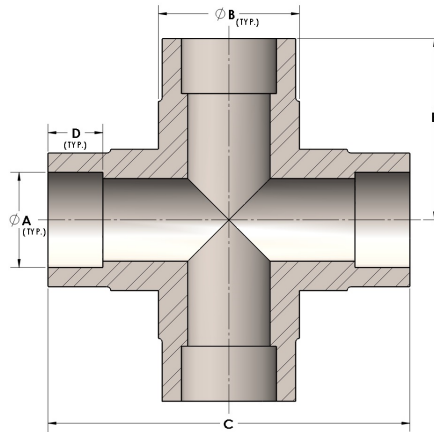

DIMENSIONS

A	0.500
B	0.75
C	2.13
D	0.310
E	1.06
F	1.44

GENERAL

Pressure Rating	6000 PSI
Fitting Material	Monel®, ASTM B164, UNS N04405