

Product Category

H819-16-M

Part Description

Direct Socketweld/Braze Cross (Tube)

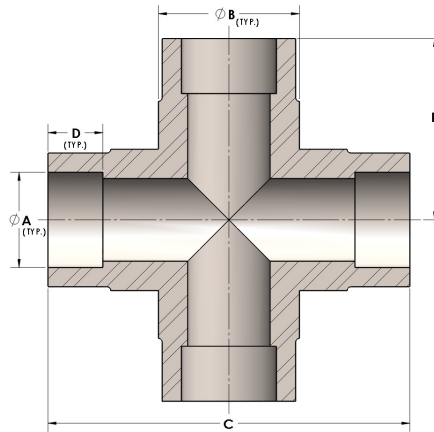

DIMENSIONS

A	1.000
B	1.38
C	3.13
D	0.500
E	1.56
F	2.25

GENERAL

Pressure Rating	6000 PSI
Fitting Material	Monel®, ASTM B164, UNS N04405