

Product Category

H819-20-M

Part Description

Direct Socketweld/Braze Cross (Tube)

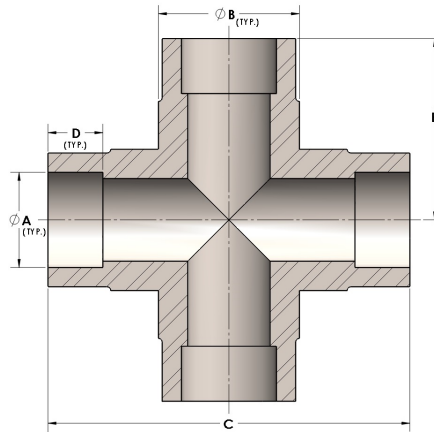

## DIMENSIONS

A	1.250
B	1.63
C	3.88
D	0.560
E	1.94
F	2.75

## GENERAL

Pressure Rating	4500 PSI
Fitting Material	Monel®, ASTM B164, UNS N04405