

Product Category

H819-24-M

Part Description

Direct Socketweld/Braze Cross (Tube)

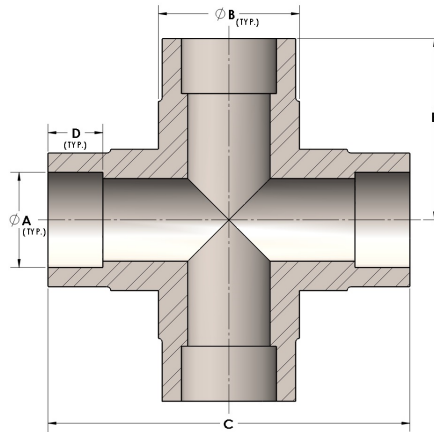

## DIMENSIONS

A	1.500
B	1.88
C	4.38
D	0.630
E	2.19
F	3.13

## GENERAL

Pressure Rating	4500 PSI
Fitting Material	Monel®, ASTM B164, UNS N04405