

Product Category

H820-06-04-M

Part Description

Socketweld/braze Tube Elbow Assembly

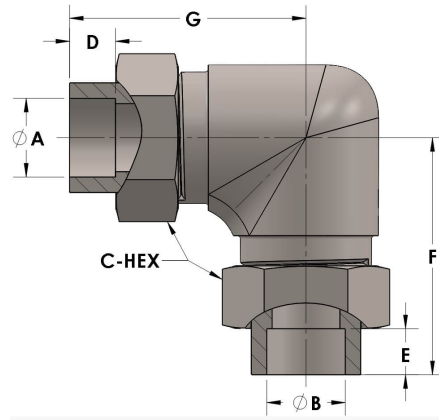

DIMENSIONS

A	0.380
B	0.25
C-HEX	0.81
D	0.190
E	0.19
F	1.44
G	1.5

GENERAL

Pressure Rating	6000 PSI
Tailpiece Material	Monel®, ASTM B164, UNS N04405
Threadpiece Material	Monel®, ASTM B564, UNS N04400
O-Ring Material	Viton® Fluorocarbon Type 1, Class 2 (90 durometer)
Connection 1 Type	Female Tube Socket
Connection 1 Size	3/8" Tube O.D. (-06)
Connection 2 Type	Female Tube Socket
Connection 2 Size	1/4" Tube O.D. (-04)