

Product Category

H820-08-06-S

Part Description

Socketweld/braze Tube Elbow Assembly

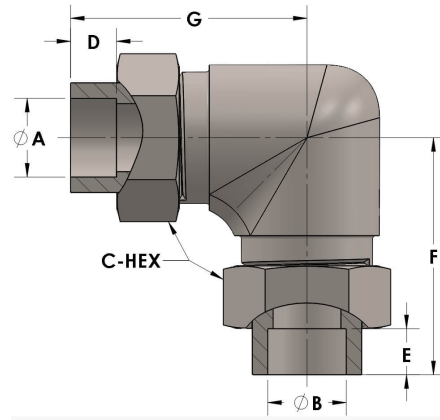

## DIMENSIONS

A	0.500
B	0.38
C-HEX	0.94
D	0.310
E	0.25
F	1.63
G	1.69

## GENERAL

Pressure Rating	4500 PSI
Assembly Material	Carbon Steel, ASTM A108
O-Ring Material	Viton® Fluorocarbon Type 1, Class 2 (90 durometer)
Connection 1 Type	Female Tube Socket
Connection 1 Size	1/2" Tube O.D. (-08)
Connection 2 Type	Female Tube Socket
Connection 2 Size	3/8" Tube O.D. (-06)