

Product Category

H820-08-SS316L

Part Description

Socketweld/braze Tube Elbow Assembly

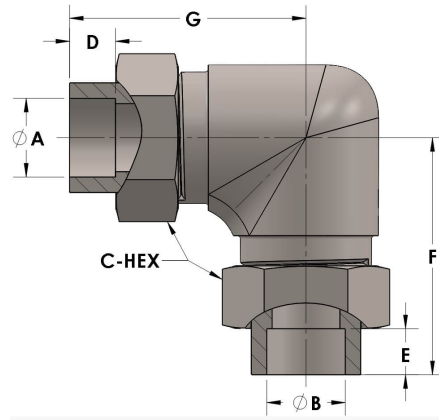

DIMENSIONS

A	0.500
B	0.50
C-HEX	0.94
D	0.310
E	0.31
F	1.69
G	1.69

GENERAL

Pressure Rating	4500 PSI
Assembly Material	316/L Stainless Steel, ASTM A276, UNS S31600/03
O-Ring Material	Viton® Fluorocarbon Type 1, Class 2 (90 durometer)
Connection 1 Type	Female Tube Socket
Connection 1 Size	1/2" Tube O.D. (-08)
Connection 2 Type	Female Tube Socket
Connection 2 Size	1/2" Tube O.D. (-08)