

Product Category

H820-10-S

Part Description

Socketweld/braze Tube Elbow Assembly

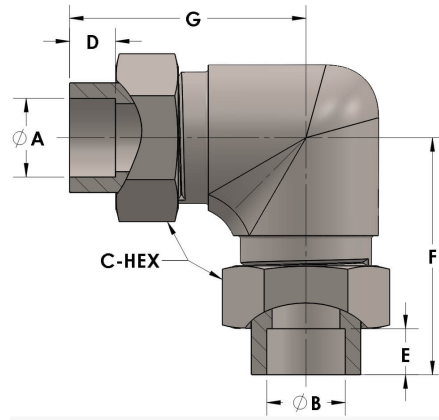

DIMENSIONS

A	0.630
B	0.63
C-HEX	1.13
D	0.380
E	0.38
F	2.06
G	2.06

GENERAL

Pressure Rating	4500 PSI
Assembly Material	Carbon Steel, ASTM A108
O-Ring Material	Viton® Fluorocarbon Type 1, Class 2 (90 durometer)
Connection 1 Type	Female Tube Socket
Connection 1 Size	5/8" Tube O.D. (-10)
Connection 2 Type	Female Tube Socket
Connection 2 Size	5/8" Tube O.D. (-10)