

Product Category

H820-12-M

Part Description

Socketweld/braze Tube Elbow Assembly

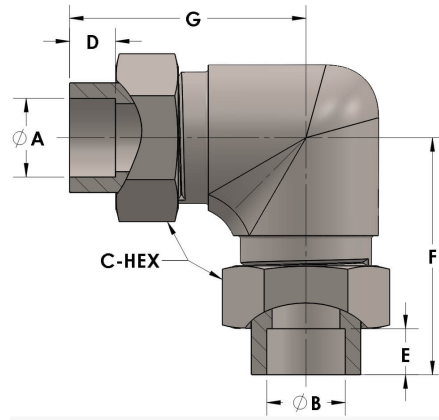

DIMENSIONS

A	0.750
B	0.75
C-HEX	1.38
D	0.440
E	0.44
F	2.25
G	2.25

GENERAL

Pressure Rating	6000 PSI
Tailpiece Material	Monel®, ASTM B164, UNS N04405
Threadpiece Material	Monel®, ASTM B564, UNS N04400
O-Ring Material	Viton® Fluorocarbon Type 1, Class 2 (90 durometer)
Connection 1 Type	Female Tube Socket
Connection 1 Size	3/4" Tube O.D. (-12)
Connection 2 Type	Female Tube Socket
Connection 2 Size	3/4" Tube O.D. (-12)