

Product Category

H821-06-08-M

Part Description

Tube to Male Pipe Thread Elbow Assembly

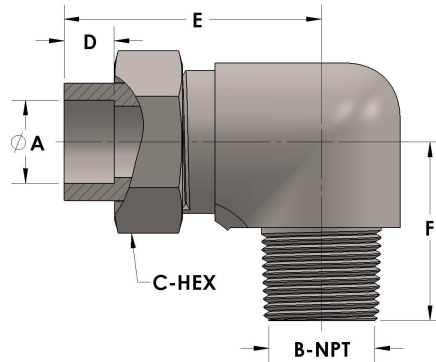

DIMENSIONS

A	0.380
B-NPT	1/2" - 14
C-HEX	0.94
D	0.250
E	1.63
F	1.44

GENERAL

Pressure Rating	6000 PSI
Tailpiece Material	Monel®, ASTM B164, UNS N04405
Threadpiece Material	Monel®, ASTM B564, UNS N04400
O-Ring Material	Viton® Fluorocarbon Type 1, Class 2 (90 durometer)
Connection 1 Type	Female Tube Socket
Connection 1 Size	3/8" Tube O.D. (-06)
Connection 2 Type	Male Pipe Thread
Connection 2 Size	1/2" NPT (-08)