

Product Category

H821-08-06-SS316L

Part Description

Tube to Male Pipe Thread Elbow Assembly

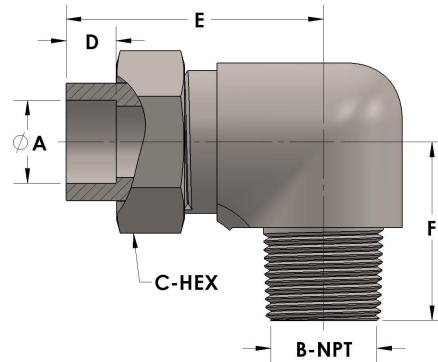

## DIMENSIONS

A	0.500
B-NPT	3/8" - 18
C-HEX	0.94
D	0.310
E	1.69
F	1.19

## GENERAL

Pressure Rating	3000 PSI
Assembly Material	316/L Stainless Steel, ASTM A276, UNS S31600/03
O-Ring Material	Viton® Fluorocarbon Type 1, Class 2 (90 durometer)
Connection 1 Type	Female Tube Socket
Connection 1 Size	1/2" Tube O.D. (-08)
Connection 2 Type	Male Pipe Thread
Connection 2 Size	3/8" NPT (-06)