

Product Category

H821-12-12-SS316L

Part Description

Tube to Male Pipe Thread Elbow Assembly

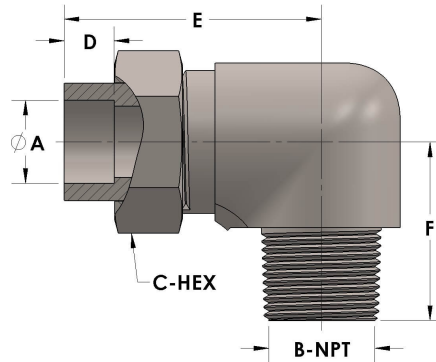

DIMENSIONS

A	0.750
B-NPT	3/4" - 14
C-HEX	1.38
D	0.440
E	2.25
F	1.56

GENERAL

Pressure Rating	6000 PSI
Assembly Material	316/L Stainless Steel, ASTM A276, UNS S31600/03
O-Ring Material	Viton® Fluorocarbon Type 1, Class 2 (90 durometer)
Connection 1 Type	Female Tube Socket
Connection 1 Size	3/4" Tube O.D. (-12)
Connection 2 Type	Male Pipe Thread
Connection 2 Size	3/4" NPT (-12)