

Product Category

H822-06-06-S

Part Description

Tube to Female Pipe Thread Elbow Assembly

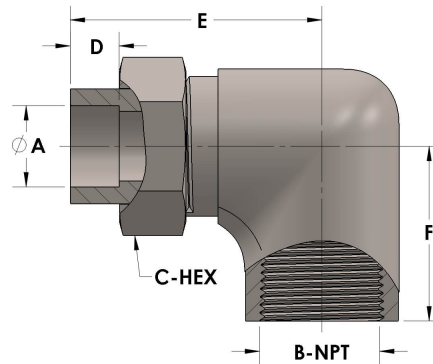

DIMENSIONS

A	0.380
B-NPT	3/8" - 18
C-HEX	0.94
D	0.250
E	1.63
F	1.19

GENERAL

Pressure Rating	4500 PSI
Assembly Material	Carbon Steel, ASTM A108
O-Ring Material	Viton® Fluorocarbon Type 1, Class 2 (90 durometer)
Connection 1 Type	Female Tube Socket
Connection 1 Size	3/8" Tube O.D. (-06)
Connection 2 Type	Female Pipe Thread
Connection 2 Size	3/8" NPT (-06)