

Product Category

H822-08-12-M

Part Description

Tube to Female Pipe Thread Elbow Assembly

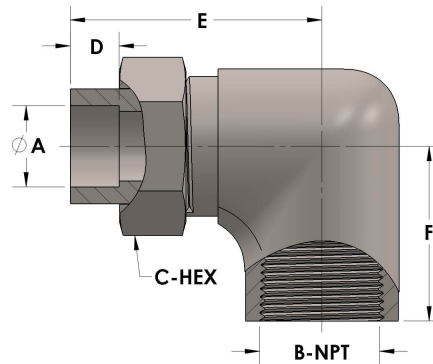

## DIMENSIONS

A	0.500
B-NPT	3/4" - 14
C-HEX	1.13
D	0.310
E	2.13
F	1.56

## GENERAL

Pressure Rating	3000 PSI
Tailpiece Material	Monel®, ASTM B164, UNS N04405
Threadpiece Material	Monel®, ASTM B564, UNS N04400
O-Ring Material	Viton® Fluorocarbon Type 1, Class 2 (90 durometer)
Connection 1 Type	Female Tube Socket
Connection 1 Size	1/2" Tube O.D. (-08)
Connection 2 Type	Female Pipe Thread
Connection 2 Size	3/4" NPT (-12)