

Product Category

H822-10-12-S

Part Description

Tube to Female Pipe Thread Elbow Assembly

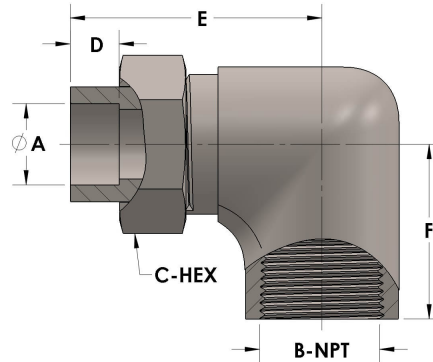

## DIMENSIONS

A	0.630
B-NPT	3/4" - 14
C-HEX	1.13
D	0.380
E	2.19
F	1.56

## GENERAL

Pressure Rating	4500 PSI
Assembly Material	Carbon Steel, ASTM A108
O-Ring Material	Viton® Fluorocarbon Type 1, Class 2 (90 durometer)
Connection 1 Type	Female Tube Socket
Connection 1 Size	5/8" Tube O.D. (-10)
Connection 2 Type	Female Pipe Thread
Connection 2 Size	3/4" NPT (-12)