

Product Category

H822-24-24-S

Part Description

Tube to Female Pipe Thread Elbow Assembly

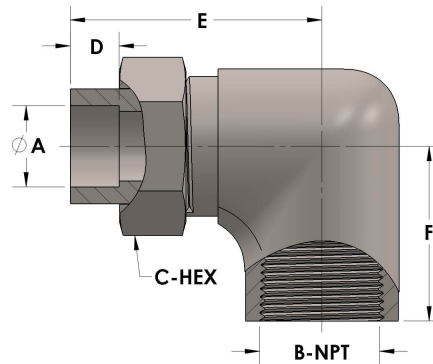

DIMENSIONS

A	1.500
B-NPT	1.500" - 11.5
C-HEX	2.38
D	0.630
E	3.31
F	2.38

GENERAL

Pressure Rating	3000 PSI
Assembly Material	Carbon Steel, ASTM A108
O-Ring Material	Viton® Fluorocarbon Type 1, Class 2 (90 durometer)
Connection 1 Type	Female Tube Socket
Connection 1 Size	1.50" Tube O.D. (-24)
Connection 2 Type	Female Pipe Thread
Connection 2 Size	1.50" NPT (-24)