

Product Category

H823-04-04-M

Part Description

Tube to Male Straight Thread Elbow Assembly

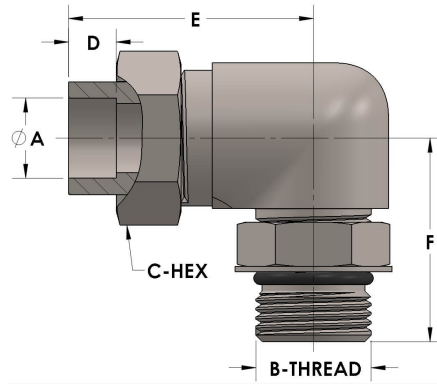

DIMENSIONS

A	0.250
B-THREAD	.438" - 20UNF
C-HEX	0.63
D	0.190
E	1.19
F	1.19

GENERAL

Pressure Rating	6000 PSI
Assembly Material	Monel®, ASTM B164, UNS N04405
O-Ring Material	Viton® Fluorocarbon Type 1, Class 2 (90 durometer)
Connection 1 Type	Female Tube Socket
Connection 1 Size	1/4" Tube O.D. (-04)
Connection 2 Type	Male Straight Thread
Connection 2 Size	.438" - 20UNF (-04)