

Product Category

H823-06-08-M

Part Description

Tube to Male Straight Thread Elbow Assembly

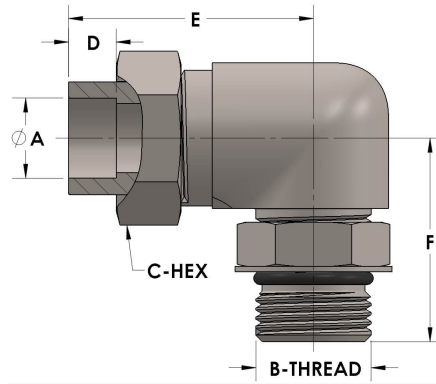

DIMENSIONS

A	0.380
B-THREAD	.750" - 16UNF
C-HEX	0.94
D	0.250
E	1.63
F	1.44

GENERAL

Pressure Rating	6000 PSI
Assembly Material	Monel®, ASTM B164, UNS N04405
O-Ring Material	Viton® Fluorocarbon Type 1, Class 2 (90 durometer)
Connection 1 Type	Female Tube Socket
Connection 1 Size	3/8" Tube O.D. (-06)
Connection 2 Type	Male Straight Thread
Connection 2 Size	.750" - 16UNF (-08)