

Product Category

H823-06-10-SS316L

Part Description

Tube to Male Straight Thread Elbow Assembly

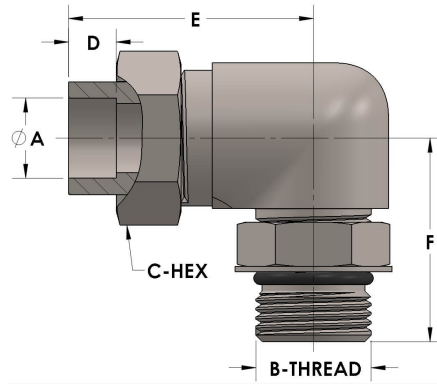

DIMENSIONS

A	0.380
B-THREAD	.875" - 14UNF
C-HEX	1.13
D	0.250
E	1.94
F	1.69

GENERAL

Pressure Rating	6000 PSI
Assembly Material	316/L Stainless Steel, ASTM A276, UNS S31600/03
O-Ring Material	Viton® Fluorocarbon Type 1, Class 2 (90 durometer)
Connection 1 Type	Female Tube Socket
Connection 1 Size	3/8" Tube O.D. (-06)
Connection 2 Type	Male Straight Thread
Connection 2 Size	.875" - 14UNF (-10)