

Product Category

H823-08-08-S

Part Description

Tube to Male Straight Thread Elbow Assembly

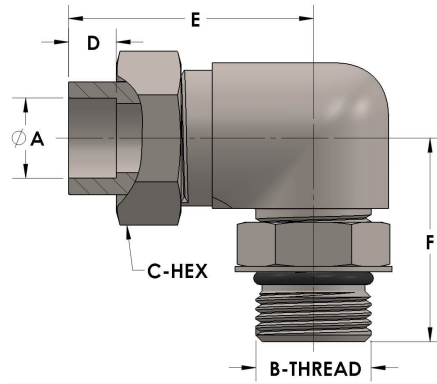

DIMENSIONS

A	0.500
B-THREAD	.750" - 16UNF
C-HEX	0.94
D	0.310
E	1.69
F	1.44

GENERAL

Pressure Rating	4500 PSI
Assembly Material	Carbon Steel, ASTM A108
O-Ring Material	Viton® Fluorocarbon Type 1, Class 2 (90 durometer)
Connection 1 Type	Female Tube Socket
Connection 1 Size	1/2" Tube O.D. (-08)
Connection 2 Type	Male Straight Thread
Connection 2 Size	.750" - 16UNF (-08)