

Product Category

H823-08-12-SS316L

Part Description

Tube to Male Straight Thread Elbow Assembly

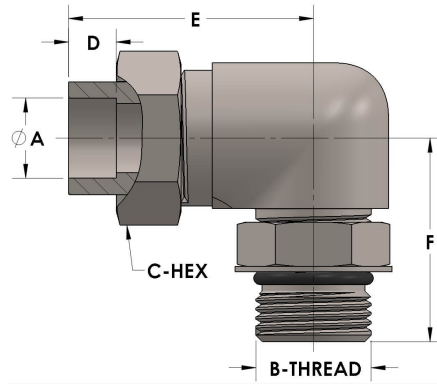

## DIMENSIONS

A	0.500
B-THREAD	1.063" - 12UN
C-HEX	1.38
D	0.310
E	2.13
F	1.94

## GENERAL

Pressure Rating	4500 PSI
Assembly Material	316/L Stainless Steel, ASTM A276, UNS S31600/03
O-Ring Material	Viton® Fluorocarbon Type 1, Class 2 (90 durometer)
Connection 1 Type	Female Tube Socket
Connection 1 Size	1/2" Tube O.D. (-08)
Connection 2 Type	Male Straight Thread
Connection 2 Size	1.063" - 12UN (-12)