

Product Category

H823-12-12-M

Part Description

Tube to Male Straight Thread Elbow Assembly

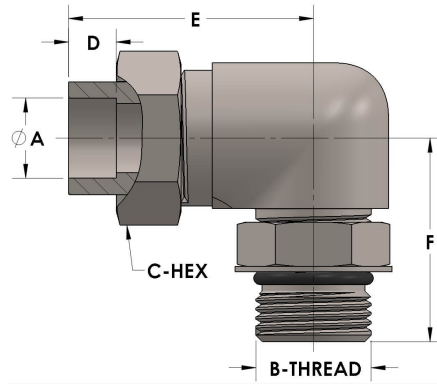

## DIMENSIONS

A	0.750
B-THREAD	1.063" - 12UN
C-HEX	1.38
D	0.440
E	2.25
F	1.94

## GENERAL

Pressure Rating	6000 PSI
Assembly Material	Monel®, ASTM B164, UNS N04405
O-Ring Material	Viton® Fluorocarbon Type 1, Class 2 (90 durometer)
Connection 1 Type	Female Tube Socket
Connection 1 Size	3/4" Tube O.D. (-12)
Connection 2 Type	Male Straight Thread
Connection 2 Size	1.063" - 12UN (-12)