

Product Category

H823-12-16-S

Part Description

Tube to Male Straight Thread Elbow Assembly

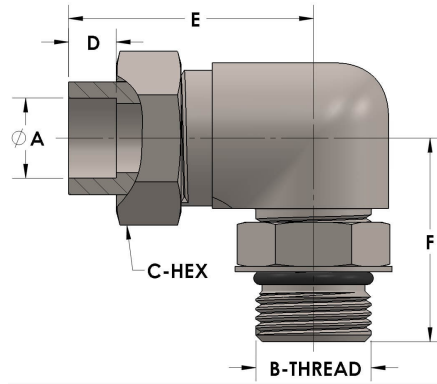

## DIMENSIONS

A	0.750
B-THREAD	1.313" - 12UN
C-HEX	1.63
D	0.440
E	2.69
F	2.06

## GENERAL

Pressure Rating	6000 PSI
Assembly Material	Carbon Steel, ASTM A108
O-Ring Material	Viton® Fluorocarbon Type 1, Class 2 (90 durometer)
Connection 1 Type	Female Tube Socket
Connection 1 Size	3/4" Tube O.D. (-12)
Connection 2 Type	Male Straight Thread
Connection 2 Size	1.313" - 12UN (-16)