

Product Category

H840-04-CUNI

Part Description

Direct Socketweld/Braze 90° Elbow (Tube)

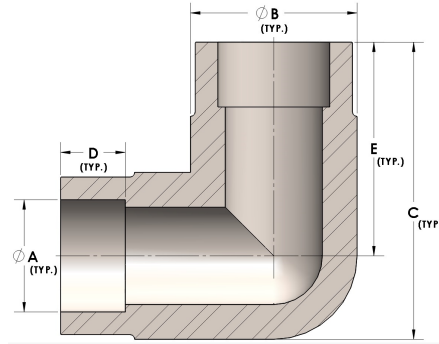

## DIMENSIONS

A	0.250
B	0.63
C	1.13
D	0.190
E	0.81

## GENERAL

Pressure Rating	6000 PSI
Fitting Material	Copper Nickel 70/30, MIL-C--15726F, UNS C71500