

Product Category

H840-08-M

Part Description

Direct Socketweld/Braze 90° Elbow (Tube)

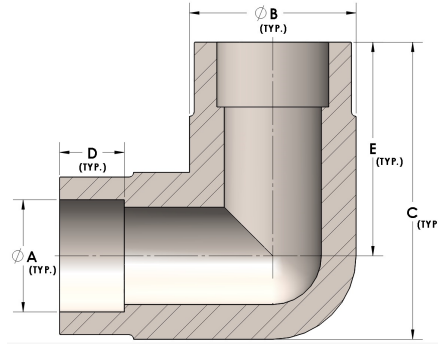

## DIMENSIONS

A	0.500
B	0.75
C	1.44
D	0.310
E	1.06

## GENERAL

Pressure Rating	4500 PSI
Fitting Material	Monel®, ASTM B164, UNS N04405