

Product Category

H840-10-S

Part Description

Direct Socketweld/Braze 90° Elbow (Tube)

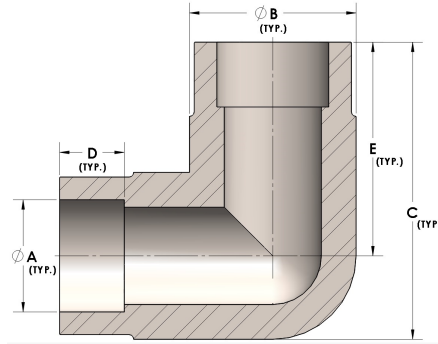

DIMENSIONS

A	0.630
B	0.88
C	1.63
D	0.380
E	1.19

GENERAL

Pressure Rating	4500 PSI
Fitting Material	Carbon Steel, ASTM A108