

Product Category

H840-12-SS316L

Part Description

Direct Socketweld/Braze 90° Elbow (Tube)

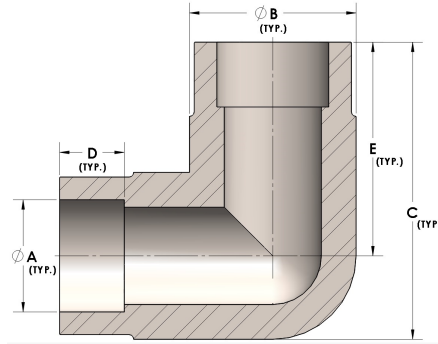

DIMENSIONS

A	0.750
B	1.13
C	2.00
D	0.440
E	1.44

GENERAL

Pressure Rating	6000 PSI
Fitting Material	316/L Stainless Steel, ASTM A276, UNS S31600/03