

Product Category

H840-16-M

Part Description

Direct Socketweld/Braze 90° Elbow (Tube)

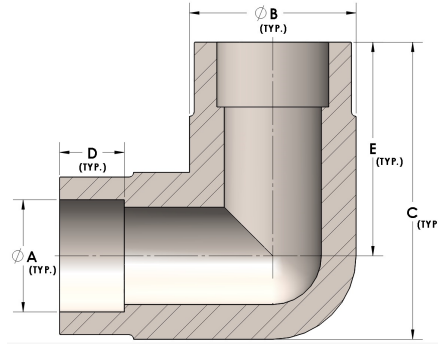

DIMENSIONS

A	1.000
B	1.38
C	2.25
D	0.500
E	1.56

GENERAL

Pressure Rating	3000 PSI
Fitting Material	Monel®, ASTM B164, UNS N04405