

Product Category

H840-20-CUNI

Part Description

Direct Socketweld/Braze 90° Elbow (Tube)

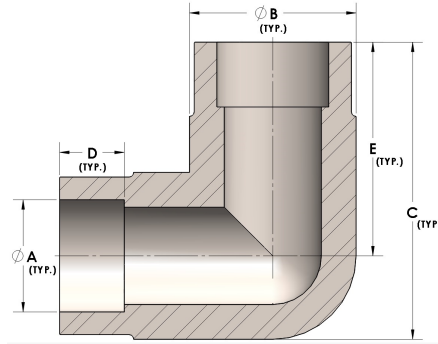

DIMENSIONS

A	1.250
B	1.63
C	2.75
D	0.560
E	1.94

GENERAL

Pressure Rating	2000 PSI
Fitting Material	Copper Nickel 70/30, MIL-C--15726F, UNS C71500