

Product Category

H840-24-S

Part Description

Direct Socketweld/Braze 90° Elbow (Tube)

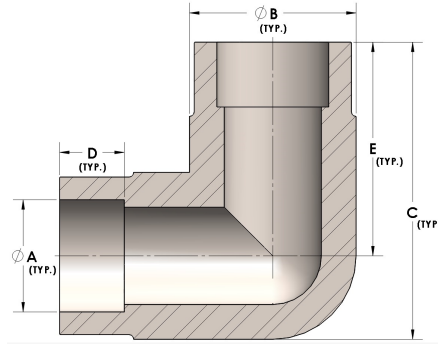

DIMENSIONS

A	1.500
B	1.88
C	3.13
D	0.630
E	2.19

GENERAL

Pressure Rating	3000 PSI
Fitting Material	Carbon Steel, ASTM A108