

Product Category

H840-32-M

Part Description

Direct Socketweld/Braze 90° Elbow (Tube)

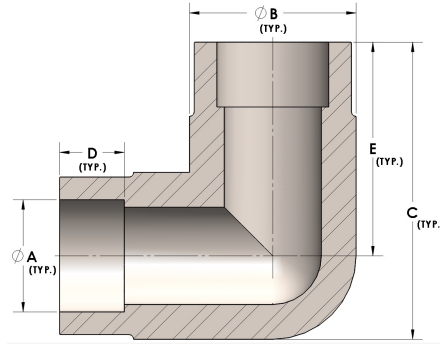

DIMENSIONS

A	2.000
B	2.75
C	4.25
D	0.880
E	2.88

GENERAL

Pressure Rating	6000 PSI
Fitting Material	Monel®, ASTM B164, UNS N04405