

Product Category

H849-02-M

Part Description

Socketweld/braze Tube Union Assembly

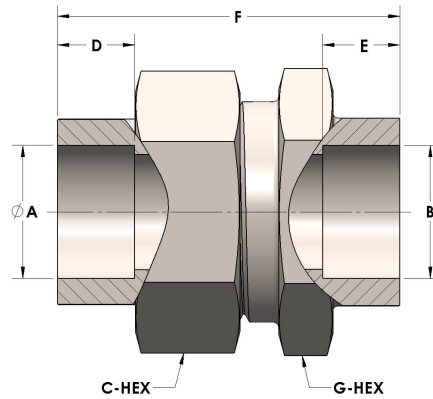

DIMENSIONS

A	0.130
B	0.13
C-HEX	0.5
D	0.190
E	0.19
F	1.00
G-HEX	0.5

GENERAL

Pressure Rating	6000 PSI
Assembly Material	Monel®, ASTM B164, UNS N04405
O-Ring Material	Viton® Fluorocarbon Type 1, Class 2 (90 durometer)
Connection 1 Type	Female Tube Socket
Connection 1 Size	1/8" Tube O.D. (-02)
Connection 2 Type	Female Tube Socket
Connection 2 Size	1/8" Tube O.D. (-02)