

Product Category

H850N-02-SS316L

Part Description

Union Nut

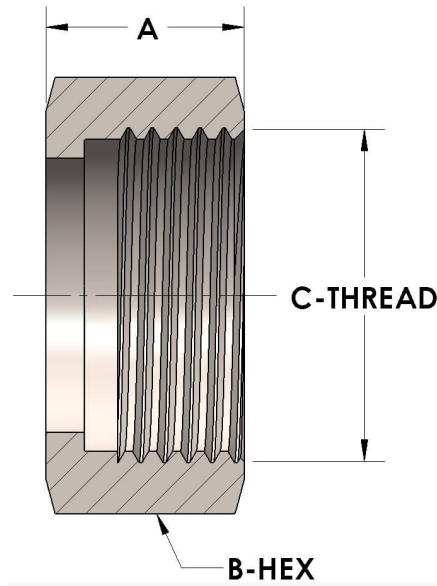

DIMENSIONS

A	0.380
B-HEX	0.5
C-THREAD	.438" - 20UNF

GENERAL

Pressure Rating	6000 PSI
Union Nut Material	316/L Stainless Steel, ASTM A276, UNS S31600/03