

Product Category

H850N-08-S

Part Description

Union Nut

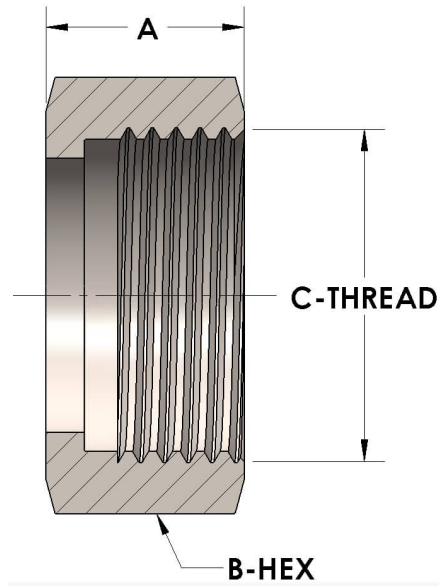

## DIMENSIONS

A	0.500
B-HEX	0.94
C-THREAD	.813" - 16UN

## GENERAL

Pressure Rating	6000 PSI
Union Nut Material	Carbon Steel, ASTM A108